

# WINTON TOPPER MOWER WTM SERIES



**OWNERS MANUAL**

**PLEASE READ THIS MANUAL BEFORE OPERATING THE MOWER**

Congratulations on purchasing your new **Winton** mower!

Before you get started, we have provided a helpful space to jot down a few important details about your new Winton machine.

Model Number: **WTM**

Serial Number:

Date of purchase:

Factory Reference: TM110/TM140/TM160

This manual should be considered a permanent part of this machine and should remain with it even if the machine is subsequently sold.

Winton continually seeks advancements in its product design and quality. Therefore, while this manual contains the most current product information available at the time of printing, there may be minor discrepancies between your machine and this manual.

If you have any questions concerning this manual, please consult your local dealer.

First Published: March 2020

## **General Safety Information**

Ensure all potential operators read this manual thoroughly before using the machine.

**Safety:** Ensure tractor and machine is stopped & keys out of ignition before set-up/maintenance.

**Safety:** Failure to follow good safety standards could result in severe injury or even death.

**Misuse:** This machine is designed for use with compact tractors, and should be used only for the indicated purpose. Winton does not take responsibility if the machine is used for any other purpose. Children must not operate the machine under any circumstance.

**Modification:** Do not modify equipment in any way. This may impair the operation and overall safety of the machine.

**Tractor requirements:** Use only with compact tractors within power range specified.

**Misuse transport:** Do not use machinery to transport personnel or livestock.

**Condition:** For the safety of personnel and optimum performance of the machine, you should check the condition of the machine and the tractor before starting. Before use check all nuts and bolts are tight.

**Spatial awareness:** Always check the operating area is safe before starting machinery.

**Operator clothing:** The operator should not wear loose clothing while operating machinery.

**Safety wear:** Always use appropriate ear protection when running a tractor and machinery. Ensure you are wearing protective gloves when servicing and using machinery.

**Bystander safety:** Ensure bystanders keep away from the machine when it is in use. Do not touch moving parts when the machine is at work.

**Public places:** When travelling on the road/public places, always keep the PTO turned off.

**Maintenance:** Always keep the machine maintained and in a good state. Where necessary, repair or replace any defective parts. Do not modify the machine.

**Sharp objects:** Pay attention to the sharp/pointed parts while servicing the machine.

**Safety guards:** All protective parts should be in good condition before operating machinery.

**Safety signs/stickers:** Keep all safety signs clean and legible. Replace any which are missing or illegible. If a component with safety sign/(s) is replaced, make sure new safety sign/(s) are attached in the same locations.

**Operating speeds:** Machinery and PTO should be operated at the recommended speed at all times.

**Safety awareness:** Good safety requires that you familiarise yourself with various safety signs, the type of warning and the area, or particular function related to that area.

**Alertness:** Never consume alcohol or drugs these can hinder alertness/coordination. Consult your doctor about using this machine while taking prescription medications.

## **General Safety Information (continued)**

### **Machinery Pre-Use Checks**

On receipt of your new Winton machine and again within the first 4 hours of use, or the 'shake in' period as we like to call it, we always recommend checking over the machine.

- Check all bolts, nuts and screws are tight on the unit.
- Tighten/check any bolts and nuts securing blades.
- If your machine has belts check the tension and adjust if required.
- Apply grease to grease points if necessary.
- Remove any stands before operating.
- Check gear oil level and top up if needed. Do not overfill.

### **Tractor Pre-Use Checks**

Check that the machine is properly attached to the tractor. Ensure that secure pins are used on the linkage mounting pins.

Be sure to add extra weights to the front of the tractor or add wheel weights if required.

Check that the tractor PTO shaft turns freely and that the machines PTO drive shaft can extend easily. Grease the PTO drive shaft using the grease points.

The chain on the PTO shaft should be checked and in a good condition. The universal joints installed should be in a good state, with proper protective parts.

Before installing the PTO shaft, the tractor and machine should be stopped and remove the key.

Install and secure all safety guards, doors and covers before starting.

Bystanders should leave the immediate area before connecting the drive from the tractor.

### **Running/Operating Checks**

- Always keep the PTO output from the tractor at **540 RPM** when running machinery.

### **Post-Use Regular Checks**



Check blades, belts and wearing parts. Be sure they are not damaged and blades swing freely in their mount. Repair or replace as required.

Clean machinery and check for/clear any entangled material which may have got stuck around any rotating parts.

# Contents

	Pg.
General Safety information	1-2
1. Dimensions and Specifications	4
2. Installation & Set Up	5
3. Cutting Height & Skid Adjustment	6
4. Blade Replacement	7
5. Gearbox Maintenance	8
6. Servicing & Maintenance	9
7. WTM Parts Diagram	10
8. WTM Parts List	11-12
9. PTO Shaft Resizing	14
10. Winton Product Warranty	15
11. FAQ's & Troubleshooting	16

## 1. DIMENSIONS & SPECIFICATIONS

Model	WTM110	WTM140	WTM160
Weight	175kg	205kg	220kg
Working Width	110cm	140cm	160cm
Blade Type			
Number Of Blades	2	2	2
Recommended Tractor HP	16-25hp	23-40hp	25-50hp
Width	120cm	152cm	170cm
Depth	135cm	155cm	175cm
Height	80cm	80cm	80cm
PTO Shaft Size	70-100cm	70-100cm	70-100cm
Cutting Height	5-25cm	5-25cm	5-25cm
Linkage Size	Category 1	Category 1	Category 1

\*Please note specifications are for indication and are subject to change without notice.

## **2. INSTALLATION & SET UP**

**Safety:** Ensure tractor and machine is stopped & keys out of ignition before set-up/maintenance.

**Safety:** Before attaching/detaching machinery ensure the hydraulic lift system is in a neutral position.

**Safety:** Make sure the PTO drive isn't connected at any point until instructed to do so.

### **Attaching The Mower**

On a flat area of ground lower the three point linkage on your tractor to its lowest position and attach the mower to the tractor using the three point linkage pins and linch pins.

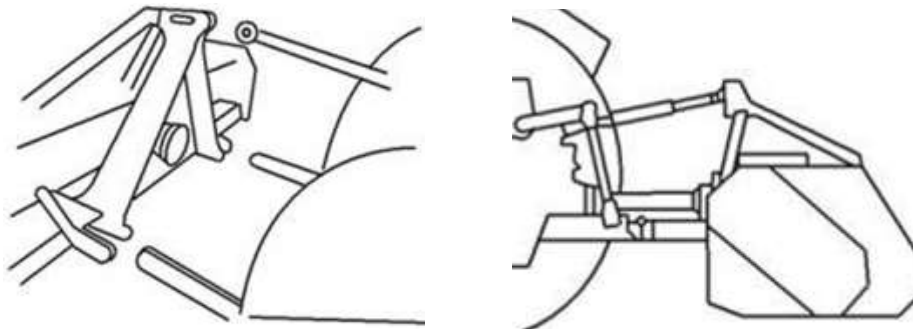

With the skids on the mower on the ground, adjust the length of the top link arm so that the skids at the side of the flail mower are parallel with the ground.

Then check the blade height underneath the machine to give an idea of the cutting height. Check clearance between the bottom of the blades and the ground, this should be at least 50mm.

Cut height should be raised for rough/lumpy paddocks or cutting long grass. This can be through raising the hydraulic lift arms on the tractor or adjusting the skids on the machine to increase the blade clearance.

The working speed of the machine should always be at a walking pace (approx. 2 to 5 mph) depending on the working conditions. Overgrown grass and weeds should be cut at a much slower pace for the best cut and to avoid any damage to the mower.

Check PTO shaft's grease points and apply grease if needed. Then attach the PTO drive shaft and ensure locking pin is secure on both the tractor and mower sides. Attach the chain to a secure point on the tractor/implement.

Operate the mower the with tractor in low range gear and the PTO delivering 540 RPM.

### **Pre-Mowing Checklist**

Before starting the machine, always check and adjust the following:

Set correct cutting height [Section 3]. Check blades [Section 4]. Check oil level in the gearbox [Section 5]. Lubricate all grease points [Section 6]. Check tightness of all bolts, nuts and screws. Ensure all protective guards are in place.

### **3. CUTTING HEIGHT & SKID ADJUSTMENT**

**Safety:** Ensure tractor and machine is stopped & keys out of ignition before set-up/maintenance.

**Note:** Clearance of blades to the ground should be at least 50mm and higher on un-even ground.

Getting the cutting height right is the key to getting the best from your mower. The cut height can be set by simply adjusting the mower deck height with the skids or raising the mower on the linkage.

Cutting height should be adjusted for the land and also the length of grass or density of weeds. The mower should be raised higher from the ground for long/overgrown grass, weeds or small shrubs.

#### **Skid Adjustment**



1. Loosen bolts and nuts **1** on the skids on both sides of the machine.
2. Move the skids up or down lining the bolt holes up at the desired height.
3. Re-tighten bolts and nuts **1**.



## **4. BLADE REPLACEMENT**

**Safety:** Ensure tractor and machine is stopped & keys out of ignition before set-up/maintenance.

**Safety:** Always wear protective gloves and take care when working with sharp blades.

Always replace worn or blunt blades for optimum cutting. Broken or chipped blades should be replaced immediately to ensure the blades do not become loose and the mower deck is balanced. It is always best to replace blades in pairs for best results. Ensure all bolts are tightened before operating.

Ensure moving parts are stationary before starting. To gain access to the blades under the deck the mower should be lifted and supported. Use support stands or blocks to hold the mower in place. Check stability of the unit when working underneath or leaving the mower at a raised height.

### **Blade removal**

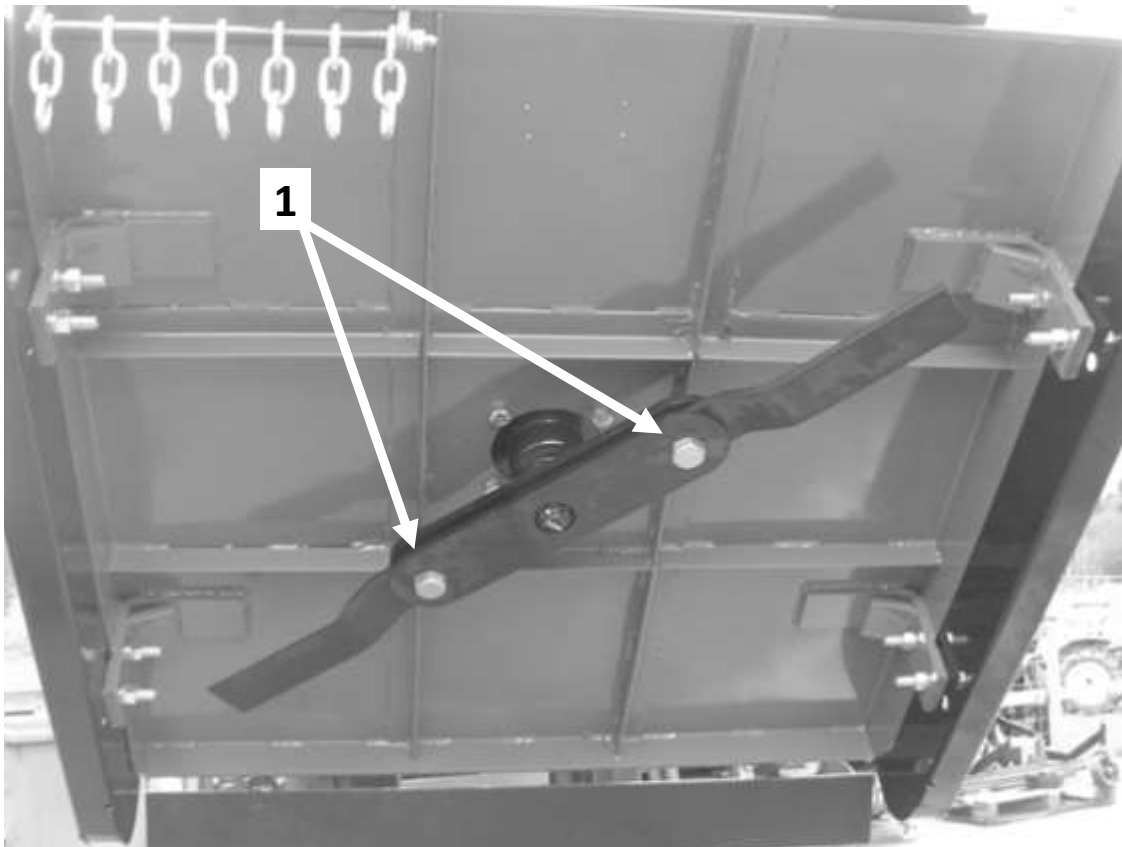

1. Loosen and remove blade bolts and nuts **1**.
2. Remove the old blades and replace with new ones.
3. Replace and tighten blade bolts and nuts **1**.

## 5. GEARBOX MAINTENANCE

**Safety:** Ensure tractor and machine is stopped & keys out of ignition before set-up/maintenance.

**Safety:** Always follow manufacturers instructions for oils and lubricants.

### Important Information

Gear Oil Grade	80w90 gear oil for all conditions (or equivalent)
Gearbox Oil Level	Approx. 0.5 litres to level plug
First Oil Change	50 hours use
Oil Change Frequency	250 hours/yearly (whichever is first)

Do not mix old and new oils together or mix different types of oil. Always dispose of old oils safely and in the correct manor. Always make sure the machine is on a flat and level surface when checking oil levels. The machine should be left at a standstill to cool down for at least 10 minutes. Ensure the machine is stable before carrying out work and will not upturn.

Draining oil: Use an oil pump to remove old oil and any debris when changing oil.

Bolt tension: Always make sure bolts are tightened correctly. The filler/level plug should be secure but not over tightened.

### Oil Change/Check Gearbox

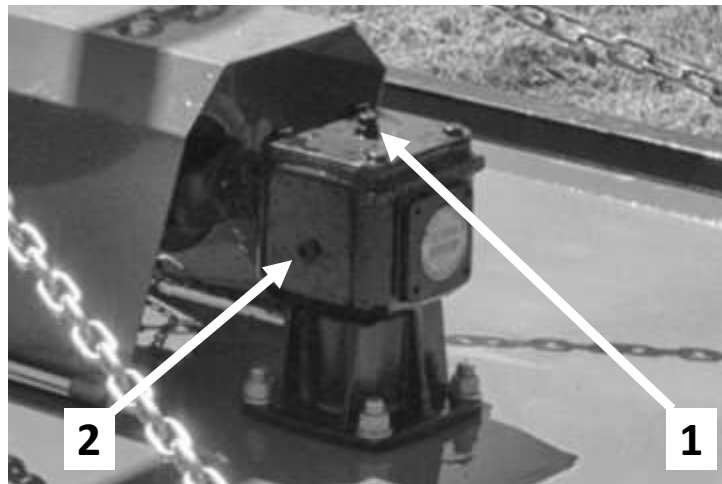

### Oil Change/Check Gearbox

1. Remove filler/breather plug **1** on top of the gearbox unit.
2. Remove level plug **2** on the side of the gearbox.
3. Add oil through the filler/breather **1** (if required). The oil should reach/begins to weep from level plug **2**.
4. Replace filler/breather plug **1** and level plug **2**.

Oil Change #1	Oil Change #2	Oil Change #3	Oil Change #4	Oil Change #5	Oil Change #6
/ /	/ /	/ /	/ /	/ /	/ /

## **6. SERVICING & MAINTENANCE**

**Safety:** Store all lubricants away from excessive heat, dust, moisture and contaminants.

**Safety:** Ensure tractor and machine is stopped & keys out of ignition before set-up/maintenance.

Grease Type	Multi-purpose lithium based grease
Grease Frequency	Check every 4-8 hours (top up if required)

### **Greasing & Lubrication Points**

#### 1. PTO shaft x2

Wipe grease nipples with a clean cloth before greasing to avoid injecting any dirt and grit. Press grease into each grease nipple three to five times. We recommend using a hand-held grease gun for best results.

If grease nipples will not take grease, remove and clean thoroughly. Also clean lubricant passageway. If you notice any grease points are broken replace or repair them immediately.

### **Other Maintenance**

**Blades:** Check condition of the blades and replace if worn/broken. Always take care when handling blades, wear gloves and use suitable tools for changing blades. If blades are replaced, check they are balanced in order to avoid any excessive vibration.

**Oils:** Ensure oil levels are checked and topped up when needed. Replace any oils per the schedule.

**PTO Shaft:** Check the condition of your PTO shaft and replace if worn or damaged immediately.

**Cleaning:** Ensure the mower deck is cleaned of mud and grass. Remove debris is from any moving parts to prevent entanglement. Do not spray water on bearings when cleaning with a high pressure washer.

**Paintwork:** Re-coat any damaged paintwork to prevent corrosion.

**Storage:** Store the machine in a dry, level area. Support the frame if necessary.

**Skids:** Check the condition of the side skids and replace if worn.

\*The periods recommended are based on normal operating conditions. Severe or unusual conditions may require more frequent maintenance.

## 7. WTM PARTS DIAGRAM

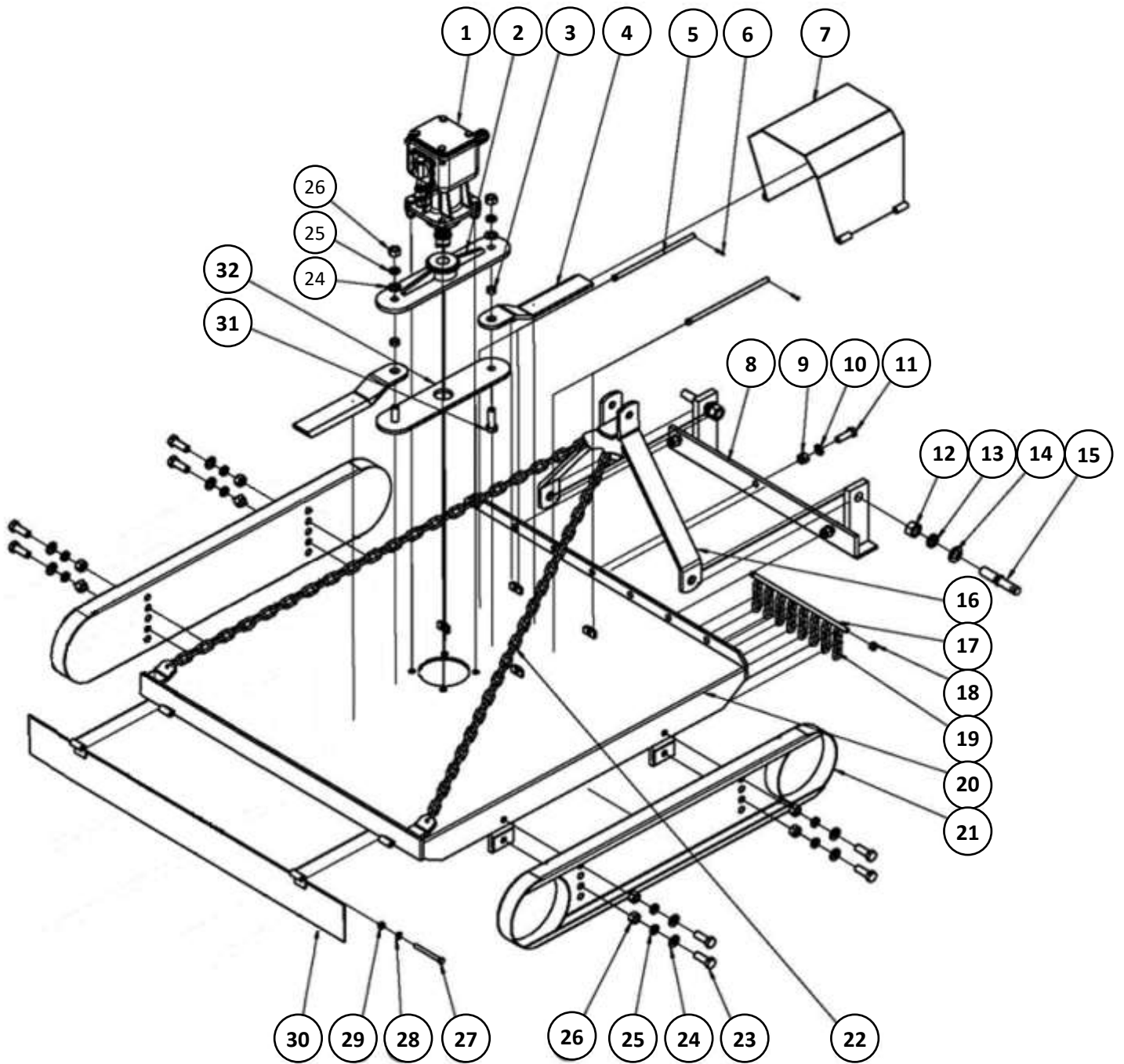

## 8. WTM PARTS LIST

Dia No.	Number	Part Number	Part Description	Qty
1	802100031	XH30.192Z.01L	Gear box	1
2	802430021	TM90.00.014	Blade support frame (110)	1
	802450003	TM140.00.014	Blade support frame (140)	1
	802460003	TM160.00.014	Blade support frame (160)	1
3	702430040	TM90.180	Blade space bushing	2
4	702340003	SL140.00.108-1	Blade (L=380)	2
5	702340006	SL140.00.112	Pin rod	2
6	508050070	GB91-3.2x20	Cotter pin	2
7	802340035	SL140.00.021	Gear box cover	1
8	802340012	SL140.00.012	Supporting structure	1
9	503010765	DIN985-M16	Lock nut	7
10	506010059	GB97.1-16	Flat washer	7
11	501011160	GB5783-M16x50	Bolt	7
12	503010053	GB6170-M24	Nut	2
13	506030043	GB93-24	Spring washer	2
14	506010063	GB97.1-24	Flat washer	3
15	702340004	SL140.00.109	Bolt	2
16	802430004	TM90.00.011	Front support frame 110	1
	802340008	SL140.00.011	Front support frame 140	1
	802340008	SL140.00.011	Front support frame 160	1
17	702340001	SL140.00.101	Chain rod	1
18	503010047	GB6170-M12	Nut	1
19	702340007	SL140.00.202	8*3 Chain	8
20	802440003	TM110.00.013	Hood 110	1
	802450007	TM140.00.013	Hood 140	1
	802460009	TM160.00.013	Hood 160	1

## 8. WTM PARTS LIST (continued)

Dia No.	Number	Part Number	Part Description	Qty
21	802440001	TM110.00.012	Adjusting skid 110	2
	802450005	TM140.00.012	Adjusting skid 140	2
	802460006	TM160.00.012	Adjusting skid 160	2
22	702440008	TM110.00.030	φ8*86 chain 110	2
	702340043	SL140.00.030	φ8*102 chain 140	2
	702460016	TM160.00.030	φ8*118 chain 160	2
23	501011179	GB5783-M18x50	Bolt	8
24	506010060	GB97.1-18	Flat washer	10
25	506030040	GB93-18	Spring washer	10
26	503010050	GB6170-M18	Nut	10
27	501010754	GB5782-M10x100	Bolt	2
28	506010056	GB97.1-10	Flat washer	2
29	503010046	GB6170-M10	Nut	2
30	802320010	SL110.00.018	Rear cover 110	1
	702340043	SL140.00.030	Rear cover 140	1
	802360006	SL160.00.018	Rear cover 160	1
31	501010792	GB5782-M18x70	Bolt	2
32	802430002	TM90.00.015	Bottom blade plate 110	1
		TM140.00.015	Bottom blade plate 140	1
	802460001	TM160.00.015	Bottom blade plate 160	1

## NOTES

## **9. PTO SHAFT RESIZING**

**Safety:** Ensure tractor & machine is stopped & keys out of ignition before carrying out any work. If you are not confident in carrying out the work consult your local supplier or mechanic.

Most PTO driven implements are supplied with a standard sized PTO shaft. As all tractors vary this often means cutting it down to size. Always replace worn or damaged PTO shafts.

Attach the machine to the tractor without the PTO shaft, raise the linkage so the PTO shaft is level/horizontal. Measure the length between tractor PTO and the machine's shaft. If the compressed (closed) PTO shaft length exceeds the one measured here then the driveline will need to be cut.

1. PTO length adjustment, first remove PTO shaft shielding.

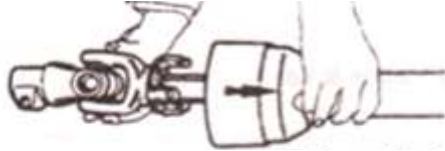

2. Shorten the driveline tubes to proper equal lengths.



3. Tidy edges of the drive tube with a file and clean all fillings from the tubes.



4. Shorten the equally long guard tubes to the same length as the driveline tubes.



5. Grease the internal driveline tube.



6. Fit the guard on the shaft.



7. Make sure that the length allows for at least 16cm (6 inches) of overlap.





## 10. WINTON PRODUCT WARRANTY

We always strive to create great products, but when something does go wrong we have a strong network of resellers on hand throughout the UK to help out.

### Warranty Claims

Before you get in touch here are 5 pieces of information your Winton reseller will need to progress your claim:

- Your invoice/order details - to include date of purchase
- Machine model number
- Machine serial number
- Details of the fault
- Images/videos of the fault

### The Terms & Conditions

All products purchased as new are covered under our 12 month warranty from the date of purchase. During this period Winton will repair or replace defective parts free of charge. This warranty is given on the proviso that the product has been used and maintained according to the Owner's Manual.

Warranty is carried out on a return to reseller / manufacturer basis and excludes any labour or delivery / collection costs.

### Exclusions

- Wearing parts are excluded; including but not limited to blades, belts and bearings.
- Modification of the product in any way will cease the manufacturers warranty.
- The machine is warranted for one year to the original purchaser, resale within the period will cease the warranty.
- Damage in transit is not covered. Claims will need to be made through the courier or your Winton reseller directly.
- Compensation for down-time, labour or loss of earnings is not covered by the warranty.
- No warranty extension will be granted for replacement parts fitted.
- Damage caused by continued use of a faulty machine will not be covered.

Your **Winton** reseller will provide their own terms and conditions upon purchase, consult this for any additional queries.

## 11. FAQ'S & TROUBLE SHOOTING

**Safety:** Ensure tractor and machine is stopped & keys out of ignition before set-up/maintenance.

WTM Problem	Solution
Patches of uncut grass	<p>Mow at 540 PTO rpm, check PTO speed &amp; tractor power output.</p> <p>Change into a lower gear on the tractor.</p> <p>Replace any missing/damaged blades.</p>
Excessive vibration	<p>Check blade rotor.</p> <p>Replace blades.</p> <p>Clean debris from mower deck area.</p> <p>Check PTO shaft for damage and replace.</p>
Gearbox noisy	<p>Check oil level and top up if required.</p> <p>Extract the oil/debris and replace with new oil.</p>
Blades scalping	<p>Raise cutting height and mower.</p> <p>Change mowing pattern/route.</p> <p>Reduce speed when turning.</p> <p>If bumpy land, level out ground before mowing.</p>
Uneven cut	<p>Change into a lower gear on the tractor.</p> <p>Level the mower using tractor linkage.</p> <p>Replace any missing/damaged blades.</p>
Tractor loaded down by mower	<p>Mow at 540 PTO rpm.</p> <p>Change into a lower gear on the tractor.</p> <p>Clean off the mower.</p> <p>Check power output on your tractor.</p>

Always consult your **Winton** dealer if you have any questions about your machine.





**W Winton**

[www.wintonmachinery.co.uk](http://www.wintonmachinery.co.uk)